



Signal Analyzer R&S FSQ

Signal analysis with the dynamic range of a high-end spectrum analyzer and a demodulation bandwidth of 28 MHz

- ◆ Up to 3.6 GHz, 8 GHz and 26.5 GHz
- ◆ 28 MHz I/Q demodulation bandwidth
- ◆ 16 Msample I and Q memory
- ◆ Software for measurements on 802.11a wireless LAN
- ◆ I/Q data extraction, e.g. for MCPA adjustment
- ◆ Code domain power measurement for 3GPP WCDMA optional
- ◆ Versatile resolution filters: Gaussian, FFT, channel, RRC
- ◆ Full choice of detectors
- ◆ Dynamic range of a high-end spectrum analyzer
 - TOI +25 dBm typ.
 - 1 dB compression +13 dBm
 - 84 dB ACLR/3GPP with noise correction



ROHDE & SCHWARZ

Future-proof performance and bandwidth

Spectrum and signal analysis in a single unit

Future transmission methods in mobile radio and related fields call for wider transmission bandwidths to handle increasing data throughput. Even today, multiple carriers of a GSM or 3GPP base station are often boosted in common power output stages. This reduces the technical effort and costs on the one hand, but increases the bandwidth to be transmitted on the other. In both cases, analysis bandwidths exceeding those provided by present-day spectrum analyzers are required in development and production, while at the same time the dynamic range must satisfy stringent requirements.

The R&S FSQ combines the outstanding spectrum analyzer features and functions of the R&S FSU with a demodulation and analysis bandwidth that has been enhanced to 28 MHz. The R&S FSQ is thus ideal for applications in the development and production of the following:

- ◆ Wireless LAN (WLAN)
- ◆ 3GPP and GSM-MCPA

The R&S FSQ additionally supports measurements on 2G, 2.5G and 3G mobile radio systems when using application firmware such as:

- ◆ R&S FS-K5, GSM/EDGE
- ◆ R&S FS-K72, 3GPP FDD BTS
- ◆ R&S FS-K73, 3GPP FDD UE

The operating concept of the R&S FSQ is identical with that of the Spectrum Analyzers R&S FSU and R&S FSP, including the GPIB/IEEC commands. These instruments thus offer a uniform platform for a variety of applications.

The R&S FSQ family

R&S FSQ3	20 Hz to 3.6 GHz
R&S FSQ8	20 Hz to 8 GHz
R&S FSQ26	20 Hz to 26 GHz



R&S FSQ – world champion in spectrum analysis

The R&S FSQ has the same outstanding RF features as the Spectrum Analyzer R&S FSU:

- ◆ 84 dB ACLR for 3GPP with noise correction
- ◆ 77 dB ACLR for 3GPP multicarrier signals (4 adjacent carriers)
- ◆ TOI >+20 dBm, +25 dBm typ.
- ◆ 1 dB compression +13 dBm
- ◆ Displayed average noise level –158 dBm (1 Hz bandwidth)
- ◆ Phase noise –160 dBc (1 Hz) at 10 MHz carrier offset
- ◆ Phase noise –123 dBc (1 Hz) at 10 kHz carrier offset

In addition to the broadband demodulation capabilities, the R&S FSQ provides the dynamic range that is required for multicarrier measurements or the measurement of spurious emissions at base transceiver stations (BTS).

Functionality

With its wide range of functions, the R&S FSQ is practically unparalleled on the spectrum analyzer market. Even the basic unit comes standard with all important functions.

Highly selective digital filters from 10 Hz to 100 kHz
Fast FFT filters from 1 Hz to 30 kHz
Channel filters from 100 Hz to 5 MHz
RRC filters
1 Hz to 50 MHz resolution bandwidth
QP detector and EMI bandwidths 200 Hz, 9 kHz, 120 kHz
2.5 ms sweep time in frequency domain
1 μs sweep time in time domain
Number of measurement points/trace selectable between 155 and 10001
Time-selective spectrum analysis with gating function
GPIB interface, IEEE 488.2
RS-232-C serial interface, 9-pin D-SUB
VGA output, 15-pin D-SUB
PC-compatible screenshots on diskette or hard disk
Up to 20 measurements/s in manual mode
Up to 30 measurements/s in GPIB mode
SCPI-compatible GPIB command set
R&S FSE/R&S FSIO-compatible GPIB command set
Fast ACP measurement in time domain
Statistical signal analysis with CCDF function
RMS detector with 100 dB dynamic range
Transducer factor for correcting antenna or cable frequency responses
2-year calibration interval
3-year warranty ¹⁾
External reference from 1 MHz to 20 MHz in 1 Hz steps
GSM/EDGE modulation measurements (with option R&S FS-K5)
Code domain power measurements for 3GPP (with options R&S FS-K72 and R&S FS-K73)
Software for measurements to WLAN 802.11a
LAN interface 100BaseT
16 Msample I and Q memory

¹⁾ Except parts subject to wear and tear (e.g. attenuators).



Future-proof performance and bandwidth

A signal analyzer with 28 MHz bandwidth – that says it all

The R&S FSQ features a newly developed digital back end that benefits from the progress in ADC and ASIC development. Time-consuming evaluation algorithms can be implemented directly in hardware – a prerequisite for fast measurement and high accuracy.

- ◆ 14-bit A/D converter 81.6 MHz
- ◆ Digital hardware resampler to match the sampling rate to the signal
- ◆ Sampling rate from 10 kHz to 81.6 MHz adaptable to the modulation rate
- ◆ SFDR >80 dBfs
- ◆ Digital downconversion to baseband with high output bandwidth (28 MHz referred to RF)

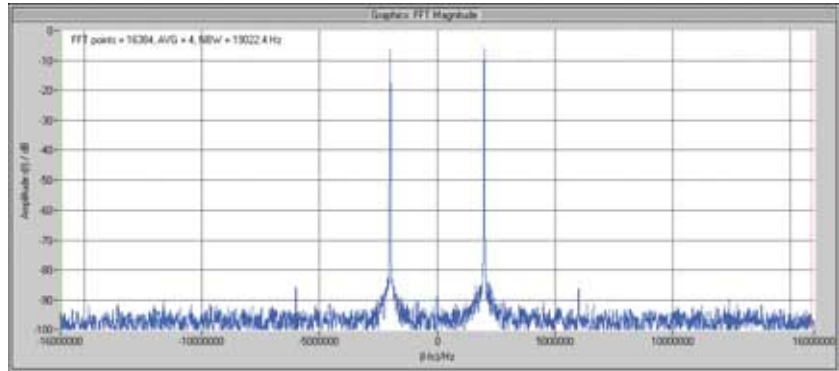

Intermodulation distortion of I/Q data: a distortion-free transmission range is particularly important for amplifier measurements; the illustration above shows the intermodulation characteristics of the I/Q data of a two-tone signal.

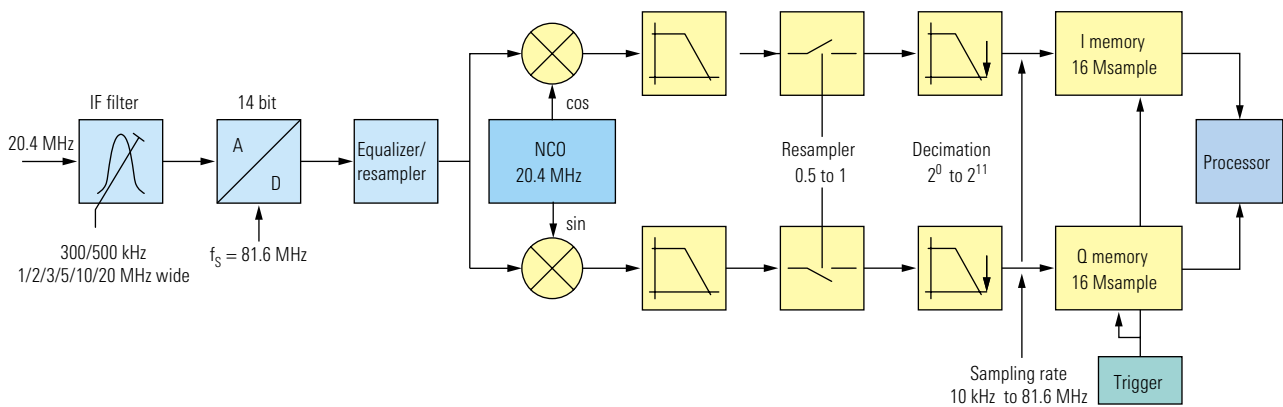

Block diagram of vector signal analysis section in the R&S FSQ

The R&S FSQ determines the linear distortion in the RF and IF paths with the aid of the built-in calibration source and corrects such distortion online using a compensation filter. Moreover, the bandwidth-limiting YIG filter can be switched off in the microwave range at carrier frequencies greater than 3.6 GHz to ensure that even the smallest modulation errors can be measured with high accuracy.

The I/Q data can be transferred to a process controller via either the IEC/IEEE bus interface or the factory-installed LAN interface and then imported into programs such as MatLab for further analysis.

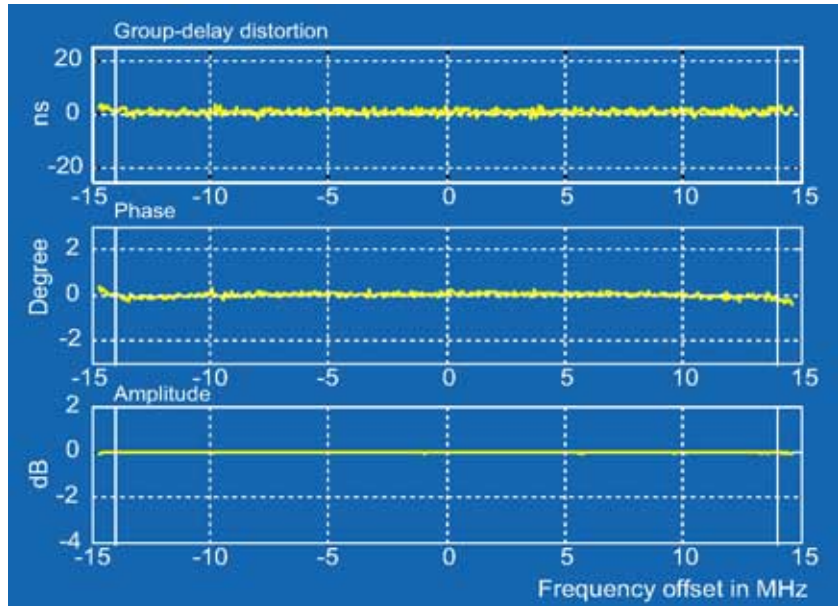

Frequency response and group-delay distortion of 20 MHz resolution filter (example)

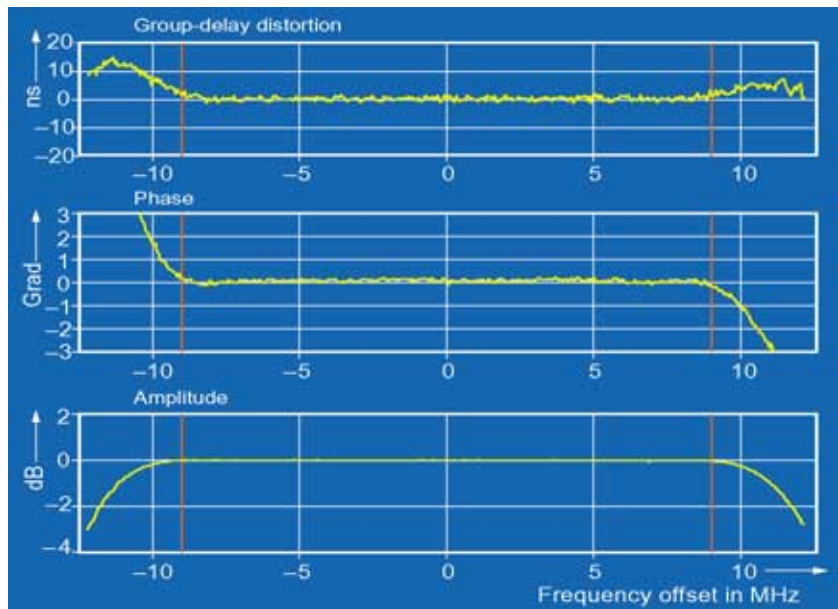

Frequency response and group-delay distortion of 50 MHz resolution filter (example)

WLAN measurements

The WLAN test software for the R&S FSQ analyzes the I/Q data that has been measured by the R&S FSQ and transferred via the IEC/IEEE bus to an external process controller in line with the requirements of the 802.11a standard:

- ◆ Modulation formats
 - BPSK
 - QPSK
 - 16QAM
 - 64QAM
- ◆ Modulation measurements
 - Constellation diagram
 - Constellation diagram per OFDM carrier
 - I/Q offset and I/Q imbalance
 - Carrier and symbol frequency errors
 - Modulation error (EVM) per OFDM carrier or symbol
 - Amplitude response and group-delay distortion (spectral flatness)
- ◆ Amplitude statistics (CCDF) and crest factor
- ◆ Transmit spectrum mask
- ◆ FFT, also over a selected part of the signal, e.g. preamble
- ◆ Payload bit information
- ◆ Recording time selectable up to 800 ms
- ◆ Trigger:
 - Free run
 - External

Typical inherent errors in 802.11a measurements

- ◆ EVM -40 dB
- ◆ Spectral flatness 0.5 dB

Using the WLAN test software, the R&S FSQ is a powerful tool for carrying out measurements in line with the relevant standard and for troubleshooting on 802.11a systems.



Test setup for the analysis of 802.11a signals

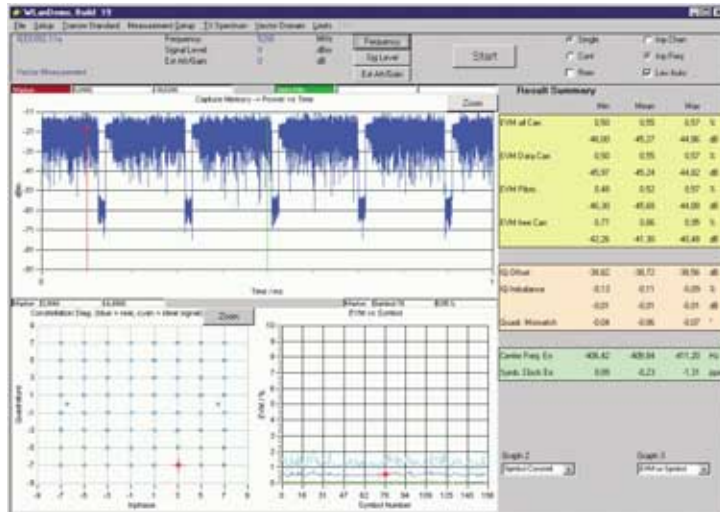

Measurement of 802.11a signal; data rate with 64QAM and simultaneous display of time characteristic, constellation diagram, EVM per OFDM symbol, and result summary with display of global error

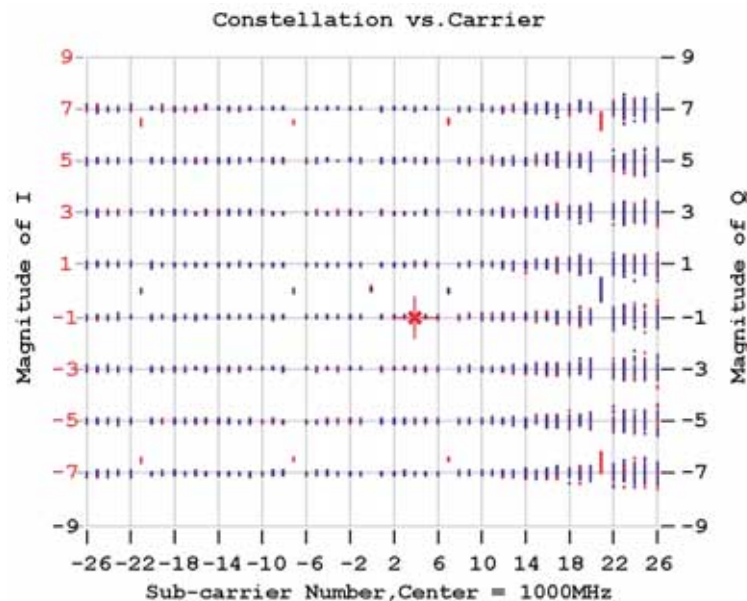

Example of adjacent-channel interference: the constellation versus carrier diagram clearly shows that the high EVM is caused by carriers on one side of the spectrum and that all steps of the 64QAM constellation are equally affected

Shorter development cycles through versatile functions ...

To handle the large variety of measurement tasks in product development, an instrument should provide ample functionality and excellent performance in every area of interest. The R&S FSQ has it all.

Full choice of detectors (Fig. 1) for matching a wide range of signal types:

- ◆ RMS
- ◆ AUTO PEAK
- ◆ MAX PEAK
- ◆ MIN PEAK
- ◆ SAMPLE
- ◆ AVERAGE
- ◆ QUASI PEAK (QPK)

The most versatile resolution filter characteristics and largest bandwidth found in a spectrum analyzer:

- ◆ Standard resolution filters from 10 Hz to 50 MHz in steps of 1, 2, 3, 5
- ◆ FFT filters from 1 Hz to 30 kHz
- ◆ 32 channel filters with bandwidths from 100 Hz to 5 MHz
- ◆ RRC filters for NADC, TETRA and 3GPP
- ◆ EMI filters 200 Hz, 9 kHz, 120 kHz

Full range of analysis functions:

- ◆ Time domain power in conjunction with channel or RRC filters make the R&S FSQ a full-fledged channel power meter (Fig. 2)
- ◆ TOI marker (Fig. 3)
- ◆ Noise/phase noise marker
- ◆ Versatile channel/adjacent-channel power measurement functions with wide selection of standards; user-configurable (Fig. 4)
- ◆ Split-screen mode with selectable settings
- ◆ CCDF measurement function
- ◆ Peak list marker for fast search of all peaks within the set frequency range (search for spurious)

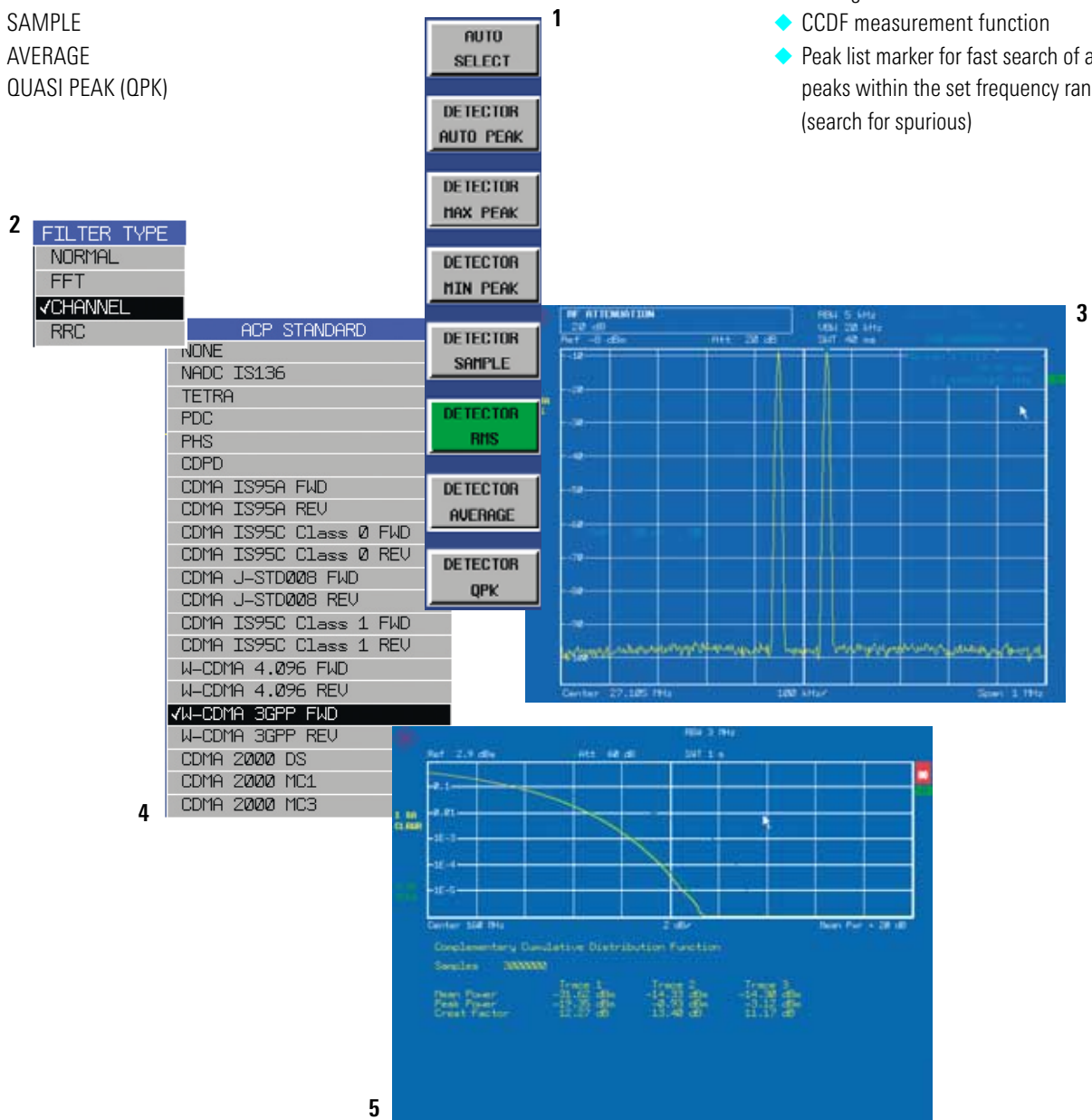

... wide dynamic range and future-proof performance

Whether in synthesizer development or front-end design, additional applications expand the R&S FSQ functionality while ease-of-use is maintained.

Phase Noise Measurement Software **R&S FS-K4** automates measurement over a complete offset frequency range, and determines residual FM from the phase noise characteristic. In conjunction with the extremely low phase noise of the R&S FSQ, this eliminates in many cases the need for an extra phase noise measurement system that may even be difficult to operate.

Noise Measurement Software **R&S FS-K3** is a convenient tool to determine the noise figure of amplifiers and frequency-converting DUTs throughout the frequency range of the R&S FSQ, thus enabling complete documentation. The high linearity and extremely accurate power measurement routines of the R&S FSQ provide precise and reproducible results, making a separate noise figure meter unnecessary.

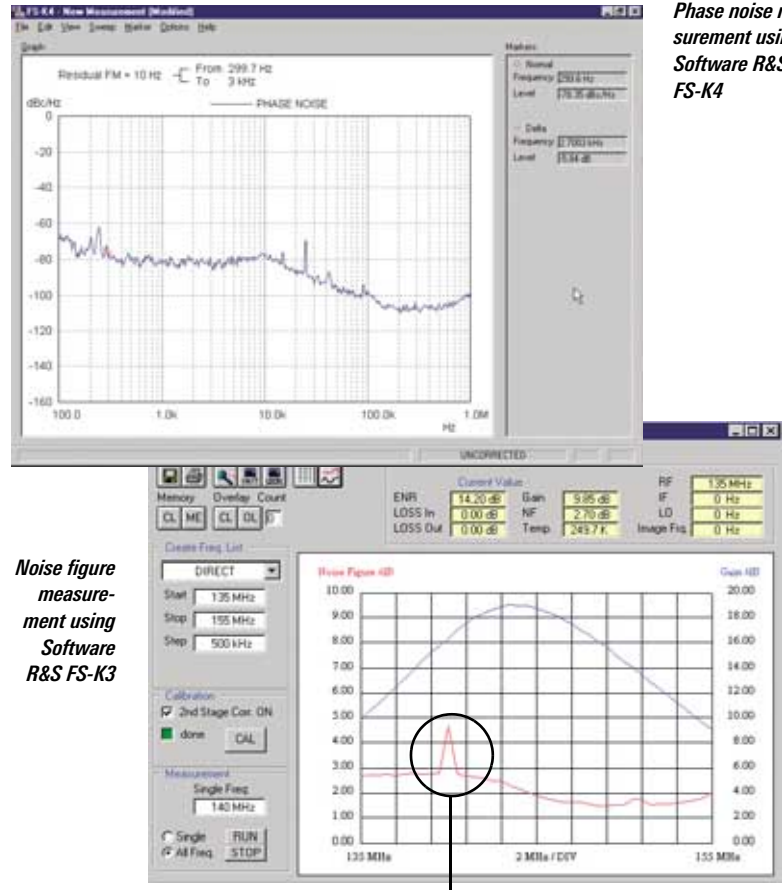

Phase noise measurement using Software R&S FS-K4

Noise figure measurement using Software R&S FS-K3

Fast and simple analysis of anomalies. The cause – spurious or RFI – can easily be traced with the basic analyzer function without additional measuring equipment.

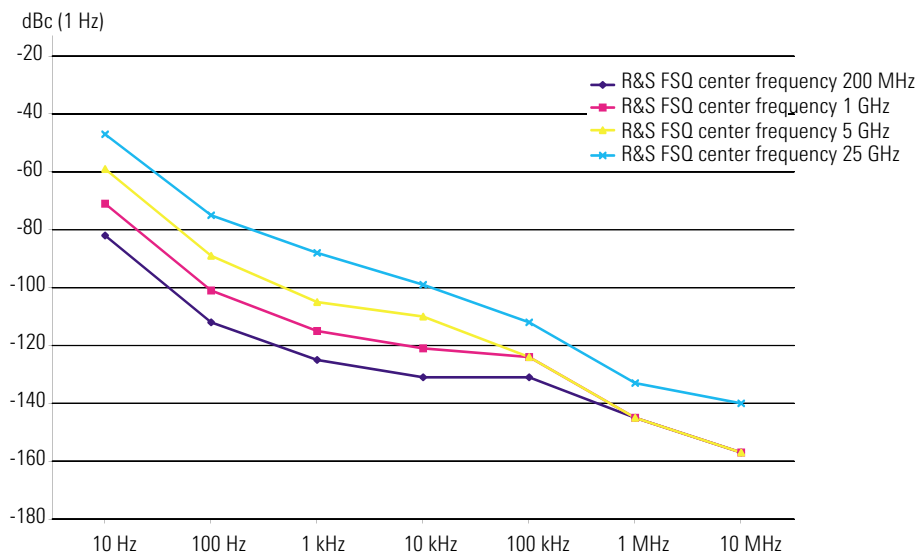

Phase noise of R&S FSQ at various center frequencies

From GSM to UMTS ...

From GSM to UMTS – fit for 3G mobile radio

In conjunction with GSM/EDGE Application Firmware **R&S FS-K5**, the R&S FSQ provides complete functionality for RF and modulation measurements in GSM systems. EDGE, which is generation 2.5, is already included in the R&S FS-K5 option.

- ◆ Phase/frequency error for GSM
- ◆ Modulation accuracy for EDGE with:
 - EVM and ETSI-conformant weighting filters
 - OOS
 - 95:th percentile
 - Power versus time with synchronization to midamble
 - Spectrum due to modulation
 - Spectrum due to transients

The above features plus the wide dynamic range make the R&S FSQ an ideal tool in base station development and testing. This is enhanced by the excellent features that are provided by the R&S FSQ as standard, such as <0.3 dB total measurement uncertainty, gated sweep function and IF power trigger.

Even in its basic version, the R&S FSQ provides the functionality and characteristics needed to develop, verify and manufacture 3G mobile radio systems:

- ◆ RMS detector, provided as standard in Rohde&Schwarz analyzers for many years and allowing accurate power measurements independently of the waveform. 3GPP specifications stipulate RMS power measurements for most tests.

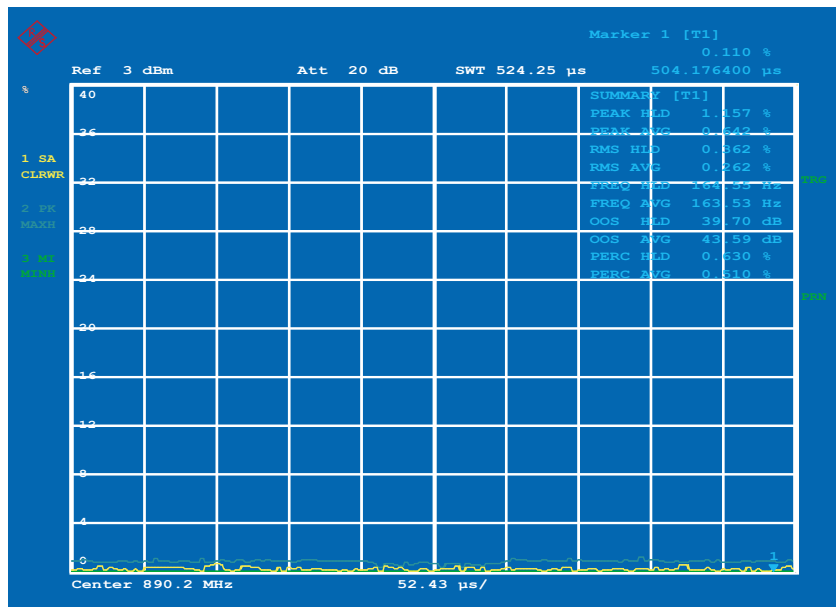

Measurement of modulation accuracy on EDGE burst

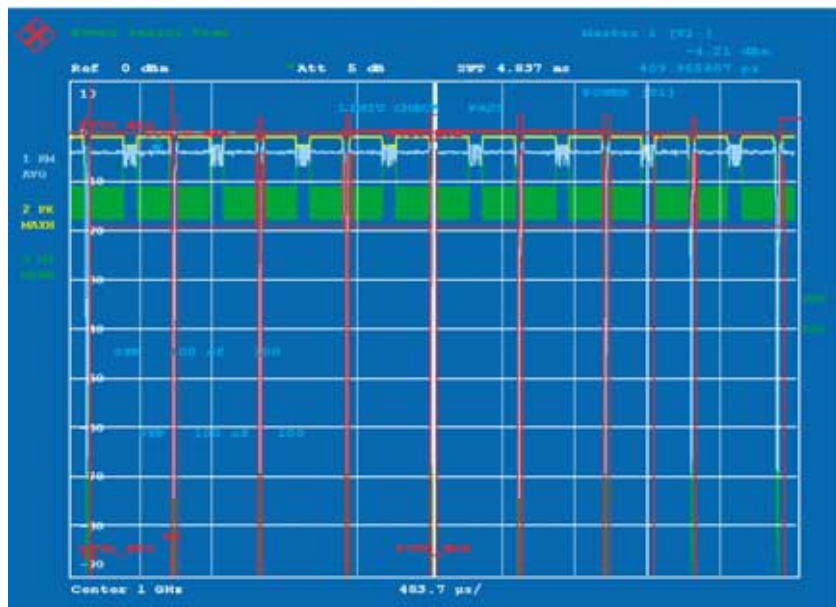

Measurement of power ramp on EDGE burst

... fit for 3G mobile radio

- ◆ ACP measurement function for 3GPP with 3.84 MHz bandwidth RRC filter for standard-conformant adjacent-channel power measurements with a dynamic range limit of 77.5 dB, or 84 dB with noise correction (one carrier)
- ◆ Dedicated CCDF measurement function that determines the probability of instantaneous signal power exceeding average power. The CCDF measurement is indispensable in determining the optimum transmit power for CDMA signals, assuming that clipping at known, short intervals is tolerable.

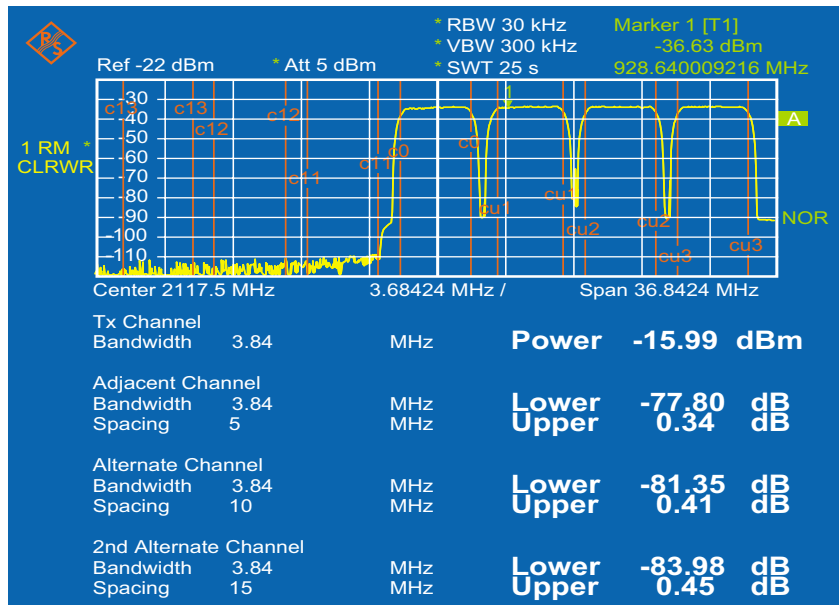

Measurement of adjacent-channel power on a 3GPP four-carrier signal with noise correction

Standard 3GPP modulation and code domain power measurements

- ◆ For BTS/NodeB signals: Application Firmware R&S FS-K72
- ◆ For UE signals: Application Firmware R&S FS-K73
- ◆ High measurement speed of 1.5 s/measurement typ.
- ◆ Code domain power and CPICH power
- ◆ EVM and PCDE
- ◆ Code domain power vs. slot
- ◆ EVM/code channel
- ◆ Spectrum emission mask

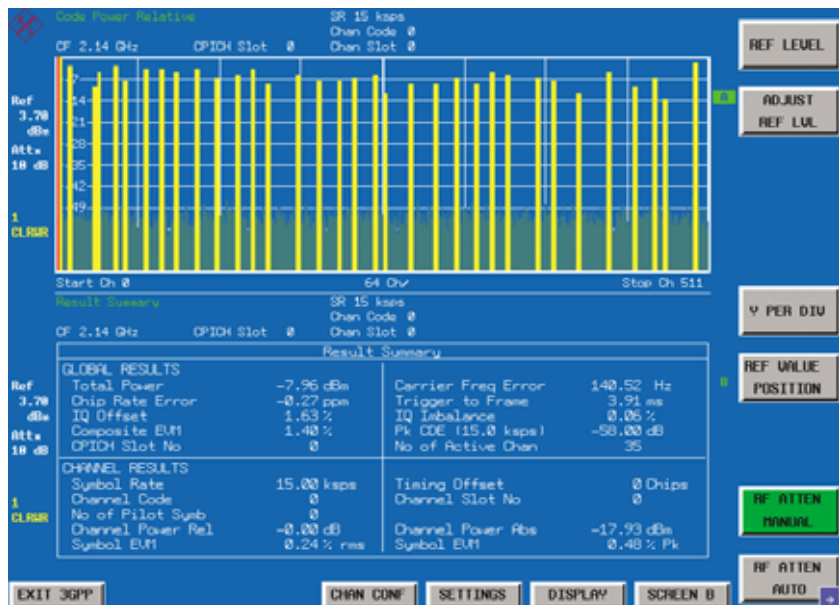

WCDMA code domain power measurement with R&S FSQ and R&S FS-K72

Take advantage of networking

Versatile documentation and networking

The standard disk drive makes it easy for you to integrate the measurement results into documentation – simply save the screen contents as a BMP or WMF file and import them into your word processing system. To process trace data, save the data as an ASCII file (CSV format), which not only documents trace data but also the main instrument settings.

Advantage of networking

The standard LAN interface opens up versatile networking capabilities:

- ◆ Link to standard network (Ethernet 10/100 BaseT)
- ◆ Running under WindowsNT, the R&S FSQ can be configured for network operation. Applications such as data output to a central network printer or saving results on a central server can easily be implemented. The R&S FSQ can thus be optimally matched to your work environment.

- ◆ Screen contents can be imported directly into MS Word for Windows or, by using an MS Excel macro, into your documentation programs. Data sheets for your products or documents for quality assurance can thus immediately be created.

Remote control via Ethernet is even simpler. The special RSIB interface links your application to the TCP/IP protocol and acts like an IEC/IEEE bus driver. The RSIB interface is available for Windows and the UNIX world. The R&S FSQ can be programmed via this interface just like on the familiar IEC/IEEE bus.

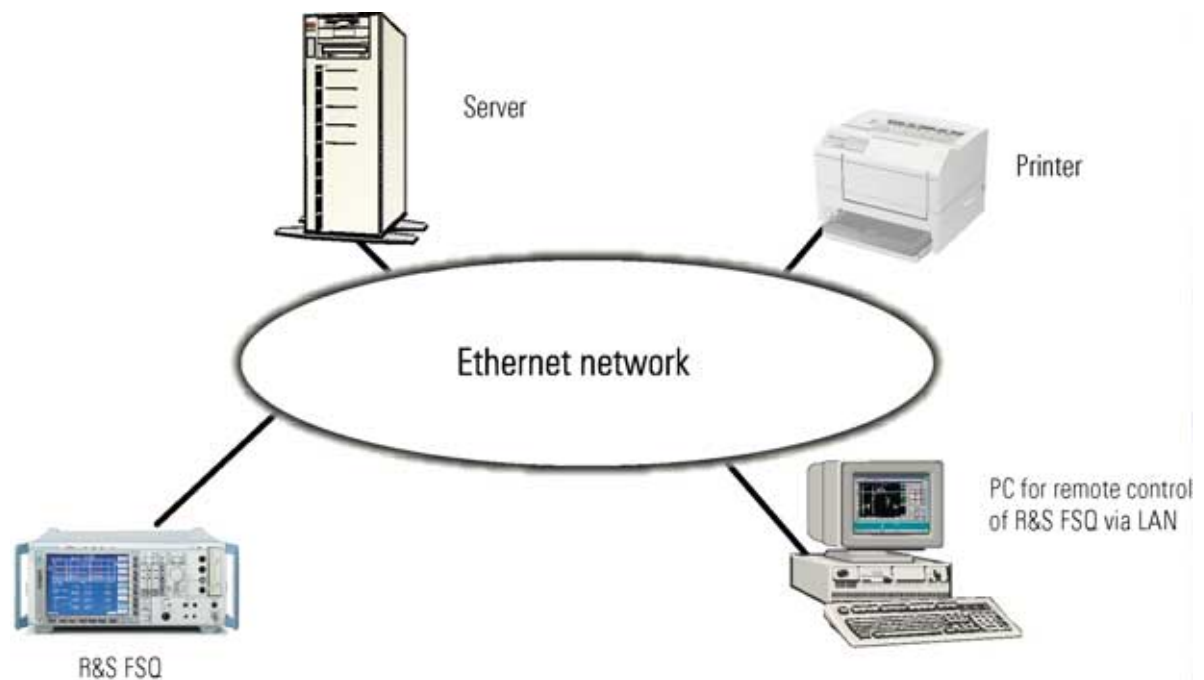

R&S FSQ in networked operation

Specifications

	R&S FSQ3	R&S FSQ8	R&S FSQ26
Specifications apply under the following conditions: 30 minutes warmup time at ambient temperature, specified environmental conditions met, calibration cycle adhered to, and total calibration performed. Data without tolerances: typical values only. Specifications designated nominal apply to design parameters and are not tested. Specification of $\sigma = xx$ dB refers to standard uncertainty.			
Frequency			
Frequency range			
DC coupled	20 Hz to 3.6 GHz	20 Hz to 8 GHz	20 Hz to 26.5 GHz
AC coupled	1 MHz to 3.6 GHz	1 MHz to 8 GHz	10 MHz to 26.5 GHz
Frequency resolution	0.01 Hz		
Internal reference frequency (nominal) with standard OCXO			
Aging per day ¹⁾	1 x 10 ⁻⁹		
Aging per year ¹⁾	1 x 10 ⁻⁷		
Temperature drift (0°C to 50°C)	8 x 10 ⁻⁸		
Total error (per year) ¹⁾	2 x 10 ⁻⁷		
Internal reference frequency (nominal); option R&S FSU-B4			
Aging per day ¹⁾	2 x 10 ⁻¹⁰		
Aging per year ¹⁾	3 x 10 ⁻⁸		
Temperature drift (0°C to 50°C)	1 x 10 ⁻⁹		
Total error (per year) ¹⁾	5 x 10 ⁻⁸		
External reference frequency			
Frequency display	1 MHz to 20 MHz, in 1 Hz steps		
Marker resolution	with marker or frequency counter		
Accuracy (sweep time >3 x auto sweep time)	0.1 Hz to 10 kHz (depending on span)		
Frequency counter resolution	$\pm(\text{marker frequency} \times \text{reference error} + 0.5\% \times \text{span} + 10\% \times \text{resolution bandwidth} + \frac{1}{2} \text{ (last digit)})$		
Count accuracy (S/N >25 dB)	0.1 Hz to 10 kHz (selectable)		
Frequency span	$\pm(\text{frequency} \times \text{reference error} + \frac{1}{2} \text{ (last digit)})$		
Resolution/accuracy of span	0 Hz, 10 Hz to 3.6 GHz	0 Hz, 10 Hz to 8 GHz	0 Hz, 10 Hz to 26.5 GHz
	0.1 Hz/1%		
Spectral purity (dBc (1 Hz)), SSB phase noise, f = 640 MHz			
Carrier offset	typ. -73 dBc (1 Hz), with option R&S FSU-B4 typ. -86 dBc		
10 Hz	<-90 dBc (1 Hz), -104 dBc (1 Hz) typ.		
1 kHz	<-112 dBc (1 Hz), -118 dBc (1 Hz) typ.		
10 kHz	<-120 dBc (1 Hz), -123 dBc (1 Hz) typ.		
100 kHz	<-120 dBc (1 Hz), -123 dBc (1 Hz) typ.		
1 MHz	<-138 dBc (1 Hz), -144 dBc (1 Hz) typ.		
10 MHz	<-155 dBc (1 Hz) nominal, -160 dBc (1 Hz) typ.		
Sweep			
Span 0 Hz	1 μ s to 16000 s in steps of 5%		
Span \geq 10 Hz	2.5 ms to 16000 s in steps \leq 10%		
Max. deviation of sweep time	3%		
Measurement in time domain	with marker and display lines (resolution 31.25 ns)		
Resolution bandwidths			
3 dB bandwidths	10 Hz to 20 MHz, in 1/2/3/5 sequence, 50 MHz		
Bandwidth accuracy			
10 Hz to 100 kHz (digital Gaussian)	<3%		
200 kHz to 5 MHz (analog Gaussian)	<10%		
10 MHz, 20 MHz	-30% to +10%		
50 MHz	-30% to +10%	-30% to +10% for f<3.6 GHz -30% to +100% for f> 3.6 GHz	
Shape factor -60 dB:-3 dB			
\leq 100 kHz	<6		
200 kHz to 2 MHz	<12		
3 MHz to 10 MHz	<7		
20 MHz, 50 MHz	<6, nominal		
Video bandwidths	1 Hz to 10 MHz, in 1/2/3/5 sequence		

	R&S FSQ3	R&S FSQ8	R&S FSQ26
FFT filters			
6 dB bandwidths	1 Hz to 30 kHz in 1/2/3/5 sequence		
Bandwidth accuracy	<5%, nominal		
Shape factor –60 dB:–3 dB	<3, nominal		
EMI filters			
6 dB bandwidths	200 Hz, 9 kHz and 120 kHz		
Bandwidth accuracy	<3%, nominal		
Shape factor –60 dB:–3 dB	<6, nominal		
Channel filters			
Bandwidth	100; 200; 300; 500 Hz; 1; 1.5; 2; 2.4; 2.7; 3; 3.4; 4; 4.5; 5; 6; 8.5; 9; 10; 12.5; 14; 15; 16; 18 (RRC); 20; 21; 24.3 (RRC); 25; 30; 50; 100; 150; 192; 200; 300; 500 kHz; 1; 1.228; 1.5; 1.516; 2; 3; 5 MHz		
Bandwidth accuracy	2%, nominal		
Shape factor –60 dB:–3 dB	<2, nominal		
Level			
Display range	displayed average noise level to 30 dBm		
Maximum input level			
DC voltage (AC coupled)	50 V		
DC voltage (DC coupled)	0 V		
RF attenuation 0 dB			
CW RF power	20 dBm (=0.3 W)		
Pulse spectral density	97 dB μ V/MHz		
RF attenuation ≥ 10 dB			
CW RF power	30 dBm (=1 W)		
Max. pulse voltage	150 V		
Max. pulse energy (10 μ s)	1 mWs		
1 dB compression of input mixer (0 dB RF attenuation)	+13 dBm nominal	+13 dBm nominal up to 3.6 GHz	
		+10 dBm nominal from 3.6 GHz to 8 GHz	+7 dBm nominal from 3.6 GHz to 26 GHz
Intermodulation			
Third-order intermodulation distortion			
Third-order intercept (TOI), level 2 x –10 dBm, $\Delta f > 5$ x RBW or 10 kHz, whichever is larger	>17 dBm, 20 dBm typ. for f=10 MHz to 300 MHz >20 dBm, 25 dBm typ. for f >300 MHz	>17 dBm, 20 dBm typ. for f=10 MHz to 300 MHz >20 dBm, 25 dBm typ. for f=300 MHz to 3.6 GHz >19 dBm, 23 dBm typ. for f=3.6 GHz to 8 GHz	>17 dBm, 20 dBm typ. for f=10 MHz to 300 MHz >22 dBm, 27 dBm typ. for f=300 MHz to 3.6 GHz >12 dBm, 15 dBm typ. for f=3.6 GHz to 26.5 GHz
Second harmonic intercept (SHI)			
$f_{in} \leq 100$ MHz	>35 dBm		
100 MHz < $f_{in} \leq 400$ MHz	>45 dBm, 55 dBm typ.		
400 MHz < $f_{in} \leq 500$ MHz	>52 dBm, 60 dBm typ.		
500 MHz < $f_{in} \leq 1$ GHz	>45 dBm, 55 dBm typ.		
1 GHz < $f_{in} \leq 1.8$ GHz	>35 dBm		
$f_{in} > 1.8$ GHz	–	>80 dBm (nominal)	
Displayed average noise level (0 dB RF attenuation, RBW 10 Hz, VBW 30 Hz, 20 averages, trace average, span 0 Hz, 50 Ω termination)			
Frequency			
20 Hz	<–80 dBm		
100 Hz	<–100 dBm		
1 kHz	<–110 dBm		
10 kHz	<–120 dBm		
100 kHz	<–126 dBm		
1 MHz	<–136 dBm		
10 MHz to 2 GHz	<–145 dBm, –148 dBm typ.		<–142 dBm, –146 dBm typ.
2 GHz to 3 GHz	<–143 dBm, –147 dBm typ.		<–140 dBm, –143 dBm typ.
3 GHz to 3.6 GHz	<–142 dBm, –146 dBm typ.		<–140 dBm, –142 dBm typ.
3.6 GHz to 7 GHz	–	<–140 dBm, –142 dBm typ.	<–141 dBm, –145 dBm typ.
7 GHz to 8 GHz	–	<–139 dBm, –141 dBm typ.	<–141 dBm, –145 dBm typ.
8 GHz to 13 GHz	–	–	<–139 dBm, –143 dBm typ.

	R&S FSQ3	R&S FSQ8	R&S FSQ26
13 GHz to 18 GHz	–		<–137 dBm, –141 dBm typ.
18 GHz to 22 GHz	–		<–135 dBm, –138 dBm typ.
22 GHz to 26.5 GHz	–		<–133 dBm, –136 dBm typ.
Log level display, RBW ≤100 kHz, S/N >20 dB			
Maximum dynamic range 1 dB compression to DANL (1 Hz)		170 dB	
Immunity to interference			
Image frequency			
f ≤3.6 GHz		>90 dB, >110 dB typ.	
f >3.6 GHz	–	>70 dB, 100 dB typ.	
Intermediate frequency			
f ≤3.6 GHz		>90 dB, >110 dB typ.	
3.6 GHz ≤ f ≤4.2 GHz	–	70 dB typ.	
f >4.2 GHz	–	>70 dB, >90 dB typ.	
Spurious responses (f >1 MHz, without input signal, 0 dB attenuation)		<–103 dBm	
Other spurious ($\Delta f >100$ kHz)			
$f_{in} <2.3$ GHz		<–80 dBc (mixer level ≤ –10 dBm)	
2.3 GHz ≤ $f_{in} <4$ GHz		<–70 dBc (mixer level ≤ –35 dBm)	
4 GHz ≤ $f_{in} <26.5$ GHz		<–80 dBc (mixer level ≤ –10 dBm)	
Level display (spectrum mode)			
Screen		625 x 500 pixels (one diagram), max. 2 diagrams with independent settings	
Logarithmic level axis		1 dB, 10 dB to 200 dB in 10 dB steps	
Linear level axis		10% of reference level per level division, 10 divisions or logarithmic scaling	
Traces		max. 6 with 2 diagrams on screen, max. 3 per diagram	
Trace detectors		Max Peak, Min Peak, Auto Peak (Normal), Sample, RMS, Average, Quasi Peak	
Trace functions		Clear/Write, Max Hold, Min Hold, Average	
Number of measurement points		625, settable between 155 and 100001 in steps of approx. factor 2	
Setting range of reference level			
Logarithmic level display		–130 dBm to (+5 dBm + RF attenuation), max. 30 dBm, in 0.1 dB steps	
Linear level display		7.0 nV to 7.07 V, in steps of 1 %	
Units of level axis		dBm, dB μ V, dBmV, dB μ A, dBpW (log level display) μ V, mV, μ A, mA, pW, nW (linear level display)	
Level measurement accuracy			
Reference error at 128 MHz, RBW ≤ 100 kHz, reference level –30 dBm, RF attenuation 10 dB		<0.2 ($\sigma = 0.07$) dB	
Frequency response (DC coupling, RF attenuation ≥10 dB)			
10 MHz to 3.6 GHz		<0.3 dB ($\sigma = 0.1$ dB) ²⁾	
3.6 GHz to 8 GHz	–	<1.5 dB ($\sigma = 0.5$ dB) ³⁾	
8 GHz to 22 GHz	–	–	<2 dB ($\sigma = 0.7$ dB) ³⁾
22 GHz to 26.5 GHz	–	–	<2.5 dB ($\sigma = 0.8$ dB) ³⁾
Attenuator (≥5 dB)		<0.2 dB ($\sigma = 0.07$ dB)	
Reference level switching		<0.15 dB ($\sigma = 0.05$ dB)	
Display nonlinearity (20 °C to 30 °C, mixer level ≤ –10 dBm)			
Logarithmic level display RBW ≤100 kHz, S/N >20 dB			
0 dB to –70 dB		<0.1 dB ($\sigma = 0.03$ dB)	
–70 dB to –90 dB		<0.3 dB ($\sigma = 0.1$ dB)	
Logarithmic level display RBW ≥ 200 kHz, S/N >16 dB			
0 dB to –50 dB		<0.2 dB ($\sigma = 0.07$ dB)	
–50 dB to –70 dB		<0.5 dB ($\sigma = 0.17$ dB)	
Linear level display		5% of reference level	

	R&S FSQ3	R&S FSQ8	R&S FSQ26
Bandwidth switching uncertainty (ref. to RBW = 10 kHz)			
10 Hz to 100 kHz		–	
200 kHz to 10 MHz		<0.2 dB ($\sigma = 0.07$ dB)	
5 MHz to 50 MHz		<0.5 dB ($\sigma = 0.15$ dB)	
FFT 1 Hz to 3 kHz		<0.2 dB ($\sigma = 0.07$ dB)	
Total measurement uncertainty (0 dB to –70 dB, S/N >20 dB, span/RBW <100, 95% confidence level, 20°C to 30°C, mixer level \leq –10 dBm)			
<3.6 GHz		0.3 dB for RBW \leq 100 kHz 0.5 dB for RBW >100 kHz	
3.6 GHz to 8 GHz	–		< 1.5 dB ²⁾
8 GHz to 22 GHz	–		< 2.0 dB ²⁾
22 GHz to 26.5 GHz	–		< 2.5 dB ²⁾
I/Q data			
General			
Sampling rate	programmable: 10 kHz to 81.6 MHz in 0.1 Hz steps		
ADC resolution	14 bit		
I/Q memory	16 Msample each for I and Q data		
RF path			
Max. information bandwidth	28 MHz		
Harmonic distortion (with full-scale input signal)	<–70 dBc typ.		
3rd order distortion (with two input tones 6 dB below full scale)	<–80 dBc typ.		
LO feedthrough ($f_{I/Q} = 81.6 \text{ MHz} - f_{\text{center}}$) (mixer level = –10 dBm)	<–65 dBfs typ.		
Aliased DC offset ($f_{I/Q} = 20.4 \text{ MHz}$, within $\pm 10 \text{ K}$ temperature change after I/Q or total calibration)	<–65 dBfs typ.		
Frequency response (within $\frac{2}{3}$ RBW; RBW = 3, 5, 10, 20, 50 MHz)			
$f \leq 3.6 \text{ GHz}$			0.3 dB typ.
$f > 3.6 \text{ GHz}$	–		0.5 dB typ.
Linear phase error (within $\frac{2}{3}$ RBW; RBW = 3, 5, 10, 20, 50 MHz)			
$f \leq 3.6 \text{ GHz}$			1° dB typ.
$f > 3.6 \text{ GHz}$			2° dB typ.
Audio demodulation			
Modulation modes			
Audio output	AM and FM		
Marker hold time in spectrum mode	loudspeaker and headphones output		
	100 ms to 60 s		
Trigger functions			
Trigger			
Span $\geq 10 \text{ Hz}$			
Trigger source	free run, video, external, IF level (selectable, mixer level 10 dBm to –50 dBm)		
Trigger offset	125 ns to 100 s, resolution 125 ns min. (or 1% of offset)		
Span = 0 Hz			
Trigger source	free run, video, external, IF level (mixer level 10 dBm to –50 dBm)		
Trigger offset	$\pm(125 \text{ ns to } 100 \text{ s})$, resolution 125 ns min., dependent on sweep time		
Trigger offset accuracy	$\pm(125 \text{ ns} + (0.1\% \times \text{delay time}))$		
Gated sweep			
Trigger source	external, IF level, video		
Gate delay	1 μs to 100 s		
Gate length	125 ns to 100 s, resolution 125 ns min. or 1% of gate length		
Gate length accuracy	$\pm(125 \text{ ns} + (0.05\% \times \text{gate length}))$		

	R&S FSQ3	R&S FSQ8	R&S FSQ26
Inputs and outputs (front panel)			
RF input	N female, 50 Ω		test port adapter APC 3.5 mm, 50 Ω
VSWR, RF attenuation ≥ 10 dB, DC coupling			
f < 3.6 GHz	<1.5		
f < 8 GHz	–	<2.0	<1.8
f < 18 GHz	–	–	<1.8
f < 26.5 GHz	–	–	<2.0
RF attenuation <10 dB, f < 3.6 GHz	1.5 typ.		
Setting range of attenuator	0 dB to 75 dB, in 5 dB steps		
Probe power supply	+15 V DC, –12.6 V DC and ground, 150 mA max. (nominal)		
Power supply for antennas	5-pin connector		
Supply voltages	± 10 V and ground, 100 mA max. (nominal)		
Power supply connector for noise source	BNC female, 0 V and 28 V, switchable, 100 mA max. (nominal)		
Keyboard	US character set		
Keyboard connector	PS/2 female for MF2 keyboard		
AF output			
NF output	3.5 mm mini jack		
Output impedance	10 Ω		
Open-circuit voltage	up to 1.5 V, adjustable		
Inputs and outputs (rear panel)			
IF 20.4 MHz	$R_i = 50 \Omega$, BNC female		
Bandwidth			
RBW < 30 kHz	1.67 x resolution bandwidth, 2.6 kHz min.		
RBW = 50 kHz, 100 kHz	400 kHz		
10 MHz \geq RBW \geq 200 kHz	same as resolution bandwidth		
Level			
RBW \leq 100 kHz, FFT	–20 dBm at reference level, mixer level > -70 dBm		
10 MHz \geq RBW \geq 200 kHz	0 dBm at reference level, mixer level > -50 dBm		
IF 404.4 MHz	$Z_{out} = 50 \Omega$, BNC female; output IF 404.4 MHz, only active if RBW > 10 MHz		
Bandwidth			
RBW > 10 MHz	same as resolution bandwidth		
Level			
Mixer level \leq 0 dBm	mixer level –10 dB typ.		
Video output	$Z_{out} = 50 \Omega$, BNC female		
Voltage (RBW \geq 200 kHz)	0 V to 1 V, full scale (open-circuit voltage), logarithmic scaling		
Reference frequency			
Output	BNC female		
Output frequency	10 MHz		
Level			
Input frequency range	1 MHz to 20 MHz in 1 Hz steps		
Required level	> 0 dBm from 50 Ω		
Sweep output	BNC female, 0 V to 5 V, proportional to displayed frequency		
External trigger/gate input	BNC female, > 10 k Ω		
Trigger voltage	1.4 V		
IEC/IEEE bus remote control	interface to IEC-625-2 (IEEE 488.2)		
Command set	SCPI 1997.0		
Connector	24-pin Amphenol female		
Interface functions	SH1, AH1, T6, L4, SR1, RL1, PP1, DC1, DT1, CO		
LAN interface	10/100Base/T, RJ45		
Serial interface	RS-232-C (COM), 9-pin D-SUB female		
Printer interface	parallel (Centronics-compatible)		
Mouse connector	PS/2-compatible		
Connector for external monitor (VGA)	15-pin D-SUB female		

	R&S FSQ3	R&S FSQ8	R&S FSQ26
General specifications			
Display	21 cm TFT LCD colour display (8.4")		
Resolution	800 x 600 pixels (SVGA resolution)		
Pixel failure rate	<1 x 10 ⁻⁵		
Mass memory	1.44 Mbyte 3½ " disk drive, hard disk		
Temperature ranges			
Operating temperature range	+5 °C to +40 °C		
Permissible temperature range	+0 °C to +50 °C		
Storage temperature range	-40 °C to +70 °C		
Damp heat	+40 °C at 95% relative humidity (DIN EN 60068-2-3)		
Mechanical resistance			
Vibration, sinusoidal	5 Hz to 150 Hz, max. 2 g at 55 Hz; 0.5 g const. from 55 Hz to 150 Hz; meets DIN EN 60068-2-6, DIN EN 60068-2-3, IEC 61010, MIL-T-28800D, class 5		
Vibration, random	10 Hz to 100 Hz, acceleration 1 g (rms)		
Shock	40 g shock spectrum, meets MIL-STD-810C and MIL-T-28800D, classes 3 and 5		
Recommended calibration interval	2 years for operation with external reference, 1 year with internal reference		
RFI suppression	meets EMC directives of EU (89/336/EEC) and German EMC law		
Power supply			
AC supply	100 V to 240 V AC, 3.1 A to 1.3 A, 50 Hz to 400 Hz, protection class I to VDE 411		
Power consumption	130 VA typ.	150 VA typ	
Safety	meets EN 61010-1, UL 3111-1, CSA C22.2 No. 1010-1		
Test mark	VDE, GS, CSA, CSA-NRTL		
Dimensions in mm (W x H x D)	435 x 192 x 460		
Weight	14.6 kg	15.4 kg	15.6 kg

¹⁾ After 30 days of continuous operation.

²⁾ Valid for temperature range 20 °C to 30 °C, <0.6 dB for temperature range 5 °C to 45 °C.

³⁾ Valid for temperature range 20 °C to 30 °C and span <1 GHz; add <0.5 dB for temperature range 5 °C to 45 °C or span >1 GHz.



Optional Electronic Attenuator R&S FSU-B25

Frequency	
Frequency range	
R&S FSQ 3	10 MHz to 3.6 GHz
R&S FSQ 8	10 MHz to 8 GHz
R&S FSQ26	10 MHz to 3.6 GHz
Setting range	
Electronic attenuator	0 dB to 30 dB, 5 dB steps
Preamplifier	20 dB, switchable
Level measurement accuracy	
Frequency response, with preamplifier or electronic attenuator	
10 MHz to 50 MHz	<1 dB
50 MHz to 3.6 GHz	<0.6 dB
3.6 GHz to 8 GHz	<2.0 dB
Reference accuracy at 128 MHz, RBW ≤ 100 kHz, reference level -30 dBm, RF attenuation 10 dB	
Electronic attenuator	<0.3 dB
Preamplifier	<0.3 dB
Displayed average noise level	
RBW = 1 kHz, VBW = 3 kHz, zero span, sweep time 50 ms, 20 averages, mean marker, normalized to 10 Hz RBW	
Preamplifier on	
10 MHz to 2.0 GHz	<-152 dBm
2.0 GHz to 3.6 GHz	<-150 dBm
3.6 GHz to 8.0 GHz	<-147 dBm
With the R&S FSU-B25 option built-in, the DANL values of the basic units degrade by (R&S FSU-B25 off):	
20 Hz to 3.6 GHz	1 dB
3.6 GHz to 8 GHz	2 dB
Preamplifier off, electronic attenuator 0 dB	
20 Hz to 3.6 GHz	2.5 dB typ.
3.6 GHz to 8 GHz	3.5 dB typ.
Intermodulation	
Third-order intermodulation, third-order intercept (TOI), electronic attenuator on, $\Delta f > 5 \times$ RBW or 10 kHz	
10 MHz to 300 MHz	>17 dBm
300 MHz to 3.6 GHz	>20 dBm
3.6 GHz to 8 GHz	>18 dBm

Ordering information

Order designation	Type	Order No.
Signal Analyzer 20 Hz to 3.6 GHz	R&S FSQ3	1155.5001.03
Signal Analyzer 20 Hz to 8 GHz	R&S FSQ8	1155.5001.08
Signal Analyzer 20 Hz to 26.5 GHz	R&S FSQ26	1155.5001.26

Accessories supplied

Power cable, operating manual, service manual, R&S FSQ26: test port adapter 3.5 mm female (1021.0512.00) and N female (1021.0535.00) connector

Options

Order designation	Type	Order No.
Options		
Highly Accurate Reference Frequency	R&S FSU-B4	1144.9000.02
External Generator Control	R&S FSP-B10	1129.7246.02
Electronic Attenuator 0 dB to 30 dB and 20 dB Preamplifier	R&S FSU-B25	1144.9298.02
Software		
Noise Measurement Software	R&S FS-K3	1057.3028.02
Phase Noise Measurement Software	R&S FS-K4	1108.0088.02
GSM/EDGE Application Firmware	R&S FS-K5	1141.1496.02
FM Measurement Demodulator	R&S FS-K7	1141.1796.02
3GPP BTS/NodeB FDD Application Firmware	R&S FS-K72	1154.7000.02
WLAN Application Software		on request

Recommended extras

Order designation	Type	Order No.
Headphones	-	0708.9010.00
US Keyboard with trackball	R&S PSP-Z2	1091.4100.02
PS/2 Mouse	R&S FSE-Z2	1084.7043.02
Colour Monitor, 17", 230 V	R&S PMC3	1082.6004.04
IEC/IEEE Bus Cable, 1 m	R&S PCK	0292.2013.10
IEC/IEEE Bus Cable, 2 m	R&S PCK	0292.2013.20
19" Rack Adapter	R&S ZZA-411	1096.3283.00
Adapter for mounting on telescopic rails (only with 19" Adapter ZZA-411)	R&S ZZA-T45	1109.3774.00

Matching Pads, 75 Ω

L Section	R&S RAM	0358.5414.02
Series Resistor, 25 Ω	R&S RAZ	0358.5714.02

SWR Bridges

SWR Bridge, 5 MHz to 3 GHz	R&S ZRB2	0373.9017.52
SWR Bridge, 40 kHz to 4 GHz	R&S ZRC	1039.9492.52

High-Power Attenuators, 100 W

3/6/10/20/30 dB	R&S RBU 100	1073.8820.XX (XX=03/06/10/20/30)
-----------------	-------------	-------------------------------------

High-Power Attenuators, 50 W

3/6/10/20/30 dB	R&S RBU 50	1073.8895.XX (XX=03/06/10/20/30)
-----------------	------------	-------------------------------------



ROHDE & SCHWARZ